



PRODUCT FEATURES

- Universal input voltage: 90~305Vac;
- Constant current design; Efficiency up to 95%;
- Isolated dimming: DALI-2 dimming;
- Dim-to-off; No glimmer after Dim-to-off;
- Standby Power: Max 0.5W;
- Flicker free: Total Output Current Ripple 5%;
- Surge protection: 4KV line-line, 6KV line-earth;
- Multiple protection: SCP, OVP, OTP;
- IP65 design for indoor and outdoor applications;
- 5 years warranty.

APPLICATION

- Suitable for industrial lighting.

DESCRIPTION

G6-DALI series is specially designed for industrial lighting applications. It is constant current LED driver that operates from 90-305Vac with DALI-2 dimming function. This round integrated structure enables it to have a better heat dissipation cooler, significantly improving reliability and extending product life. To ensure trouble free operation, protection is provided against input surge, output over voltage, short circuit, and over temperature.

MODELS

Model Number	Max Output Power (W)	Output Voltage Range (Vdc)	Output Current Adjustable Range (A)	Default Output Setting	Typical Efficiency	Power Factor	
						115Vac	230Vac
G6-200D260H	200	180~260	0.093~0.930	0.930A	96%	0.99	0.96

Notes:

1. H Version: Hard cut off after Dim-to-off, No glimmer with LEDs;
2. All parameters not specially mentioned are measured at 230Vac input, full load and 25°C of ambient temperature.

OPERATING AREA I-V

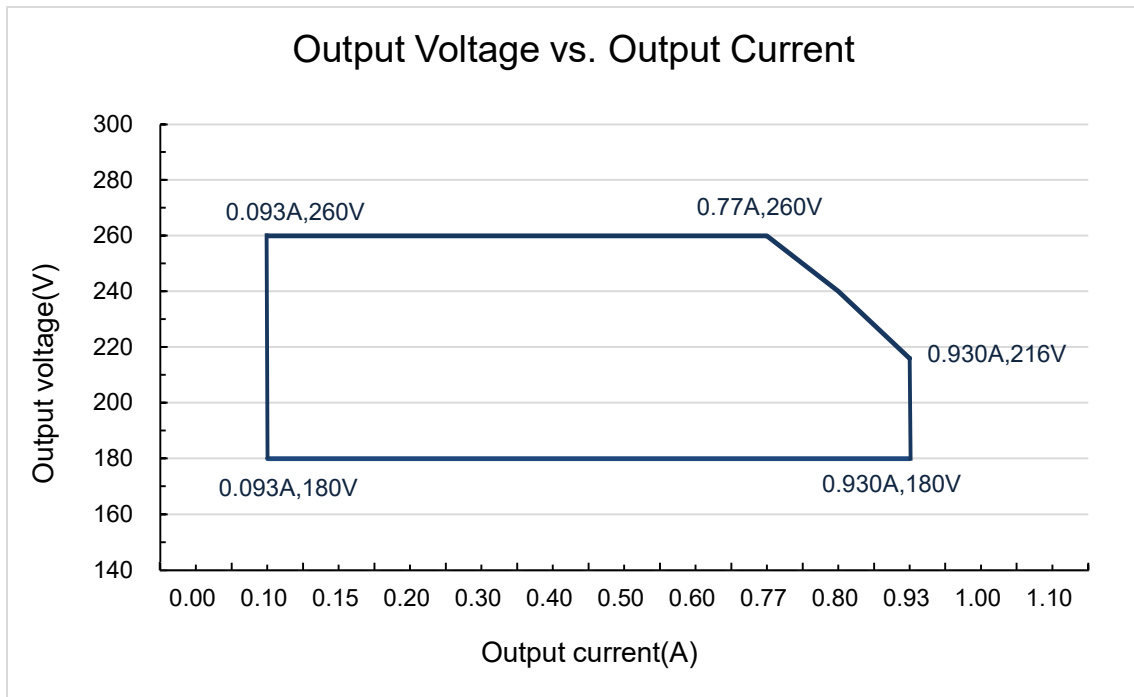

INPUT SPECIFICATIONS

Parameter	Min.	Typ.	Max.	Notes
Input Voltage	90Vac	100-277Vac	305Vac	
Input Frequency	47Hz	50/60	63Hz	
Leakage Current	-	-	0.75mA	277Vac/60Hz
Input AC Current	-	-	3.0A	100-277Vac & full load
Inrush Current(I2T)	-	-	1.5A2S	230Vac, full load
Power Factor	0.98	0.99	-	115Vac, full load
	0.95	0.96	-	230Vac, full load
	0.94	0.96	-	277Vac, full load
THD	-	5%	10%	120-230Vac, 80%-100% Load
	-	7%	10%	277Vac, 80%-100% Load

OUTPUT SPECIFICATIONS

Parameter	Min.	Typ.	Max.	Notes
Output Current Tolerance	-8%	-	+8%	
Output Current Range (A)	0.093	-	0.930	
Total Output Current Ripple (pk-pk)	-	5%	10%	20MHz BW, 100% Load & load is LED, ripple is different with difference LED load
Startup Overshoot Current	-	-	10%	100~277Vac & 100% Load, load is LED
No Load Output Voltage(V)	-	295V	320V	25°C±10°C ambient temperature, input voltage changes from 100Vac to 277Vac
Standby Power G6-200D260			0.5W	Dim to off
Line Regulation	-1%	-	+1%	25°C±10°C ambient temperature, 230Vac input, load changes from 80% to 100%.
Load Regulation	-3%	-	+3%	115Vac, 100%Load
Turn-on Delay Time	-	-	1.0S	230Vac, 100%Load
	-	-	0.5S	25°C±10°C ambient temperature, 230Vac, 100% Load

GENERAL SPECIFICATIONS

Parameter	Min.	Typ.	Max.	Notes
Efficiency @115Vac	90%	93%	-	25°C±10°C ambient temperature, 100% Load,
Efficiency @230Vac	93%	96%	-	25°C±10°C ambient temperature, 100% Load,
Efficiency @277Vac	94%	96%	-	25°C±10°C ambient temperature, 100% Load,
Dielectric Strength	Input-PE	-	1650Vac	10mA/60S
	Output- PE	-	-	
Grounding Resistance	-	-	0.1Ω	25A/60S
Insulation Resistance	50MΩ	-	-	Input-PE, Output-PE, 500Vdc/60S/ 25°C/70%RH
MTBF	-	200000Hrs	-	25°C±10°C ambient temperature, 230Vac, 80% load (MIL-HDBK-217F)
Lifetime	-	50000 Hrs	-	230Vac & 100% load, 70°C case temperature, refer to lifetime VS Tc curve for details
Operating Case Temperature for Safety Tc _s	-40°C	-	+85°C	
Operating Case Temperature for Warranty Tc _w	-40°C	-	+75°C	5 years warranty Humidity: 10% to 95% RH
Storage Temperature	-40°C	-	+85°C	Humidity: 5% to 100% RH
Dimensions (D×H)mm	Φ130×64.6			
Net Weight	950±150g/PCS			
Package	L490*W370*H175mm; 12PCS/Ctn.			

DIMMING

Parameter	Min.	Typ.	Max.	Parameter
High Voltage Level	9.5V	16V	22.5V	
Lower Voltage Level	-6.5V	0V	6.5V	
Dimming Output Range	5%Imax	-	100%Imax	Imax=0.930A; Dim to off <5%
Sink Current	-	-	2.0mA	

SAFTY STANDARDS

Safety Category	Country / Territory	Standards	Whether have Certification
CCC	China	GB19510.1, GB19510.14	√
CE	Europe	EN61347-1, EN61347-2-13	√
		EN62493	√
		EN62384	√
ENEC			
CB	CB Countries	IEC61347-1, IEC61347-2-13	√
BIS	India	IS 15885(PART 2/SEC 13)	
UL	USA	UL 8750	
CUL	Canada	CSA C22.2 No.250.13	
KC	South Korea	K61347-1, K61347-2-13	√
PSE	Japan	J61347-1, J61347-2-13	
SAA	Australia	AS/NZS IEC 61347.2.13	√
		AS/NZS 61347.1	√

EMC COMPLIANCE

EMC Category	Country / Territory	Standards	Whether have Certification
CCC	China	GB/T 17743, GB 17625.1	√
CE	Europe	EN 55015	√
		EN 61000-3-2, EN 61000-3-3	√
		EN61000-4-2,3,4,5,6,11	√
		EN 61547	√
KC	South Korea	K61547, K00015	√
PSE	Japan	J55015	
FCC	USA	FCC part 15	

NOTE:

This LED driver meets the EMI specifications above, but EMI performance of a luminaire that contains it depends also on the other devices connected to the driver and on the fixture itself.

INRUSH CURRENT WAVEFORM

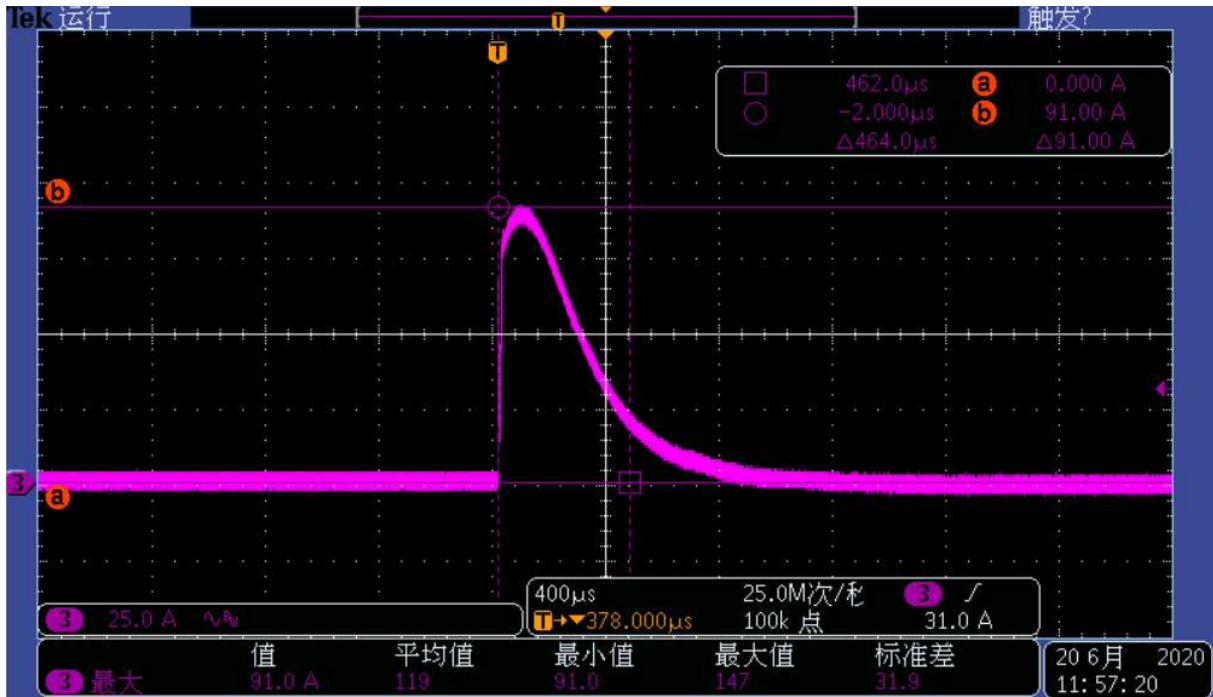

DERATING CURVE

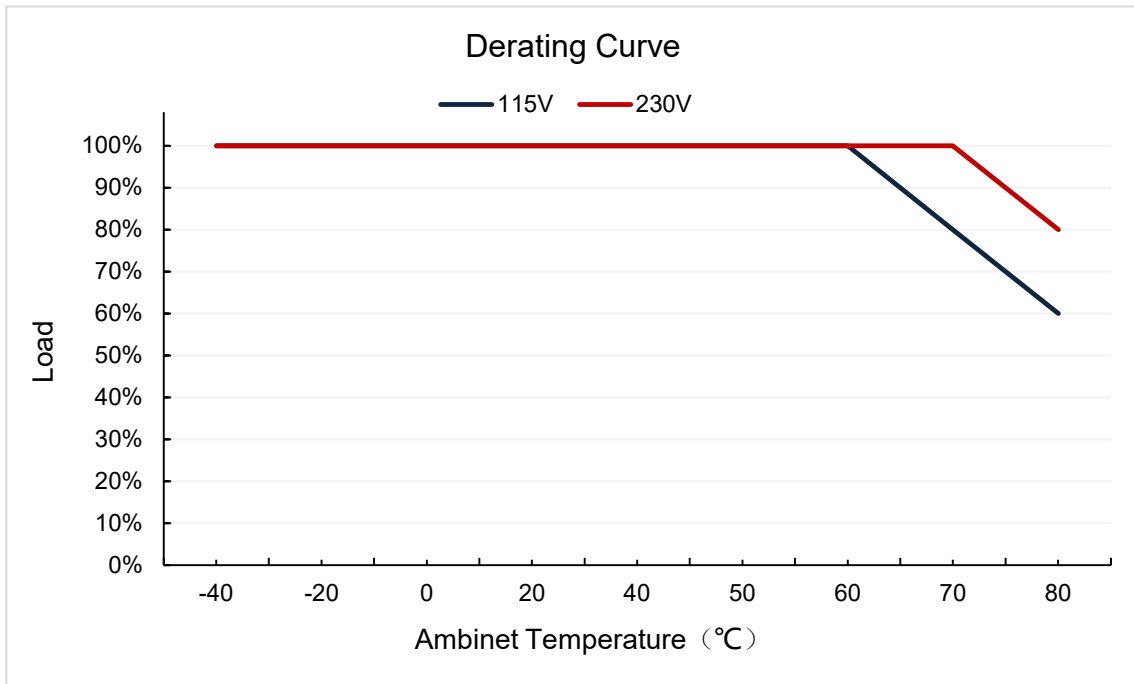

OUTPUT POWER VS INPUT VOLTAGE

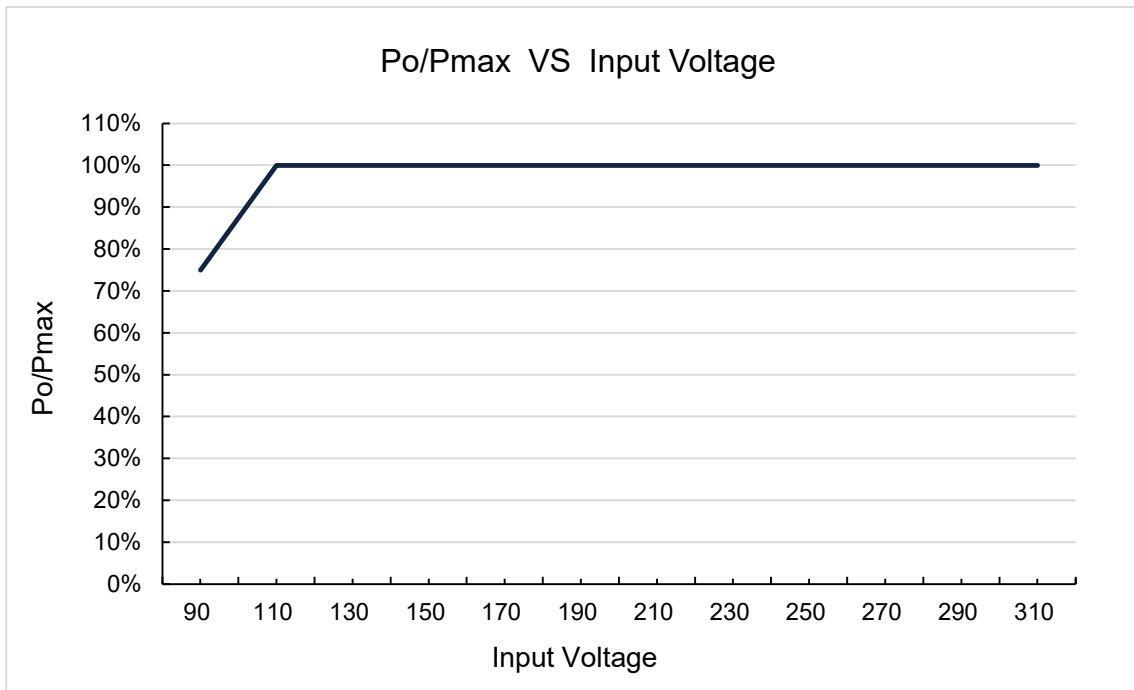

LIFETIME VS CASE TEMPERATURE

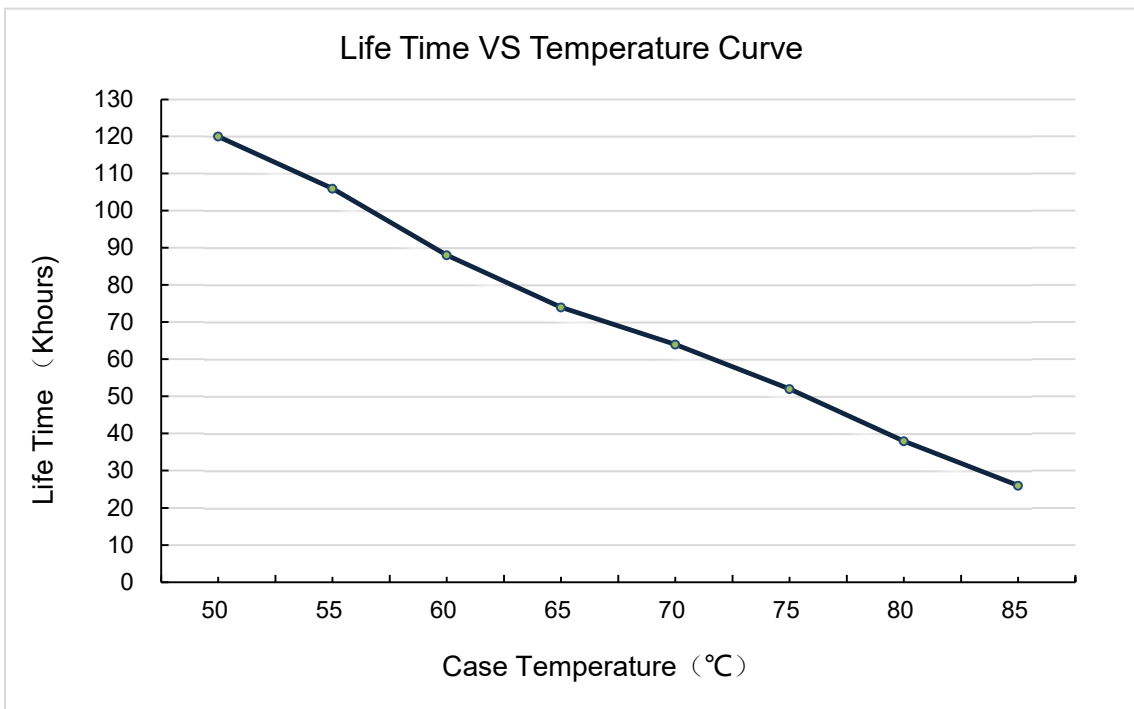

EFFICIENCY VS LOAD

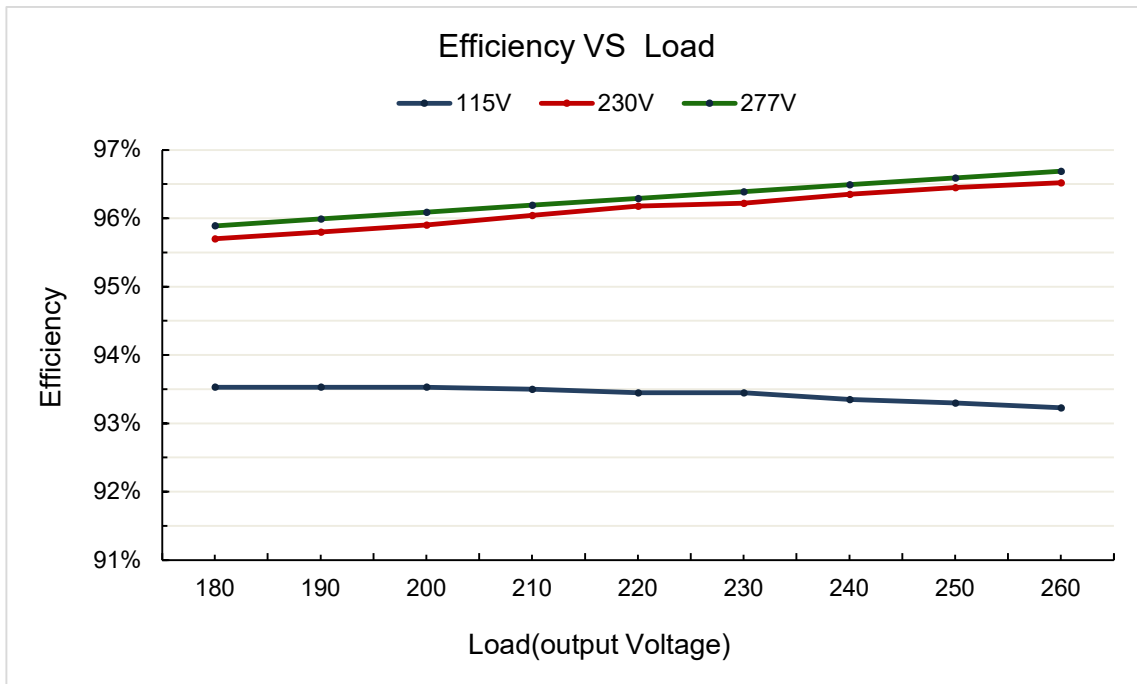

POWER FACTOR VS LOAD

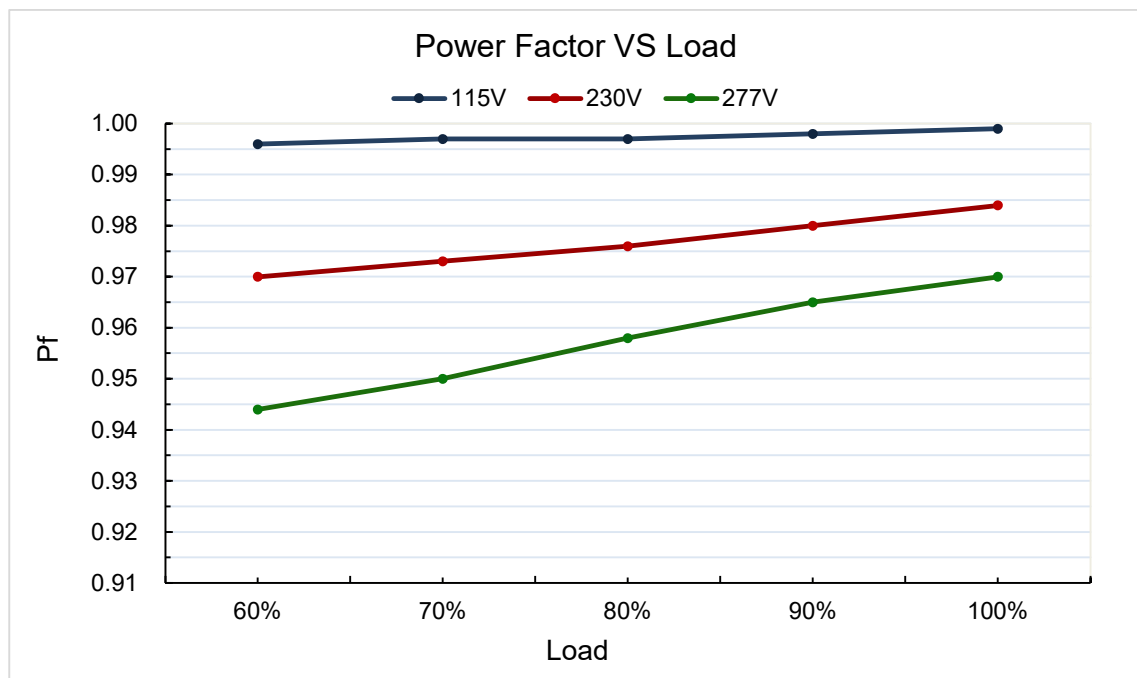

TOTAL HARMONIC DISTORTION

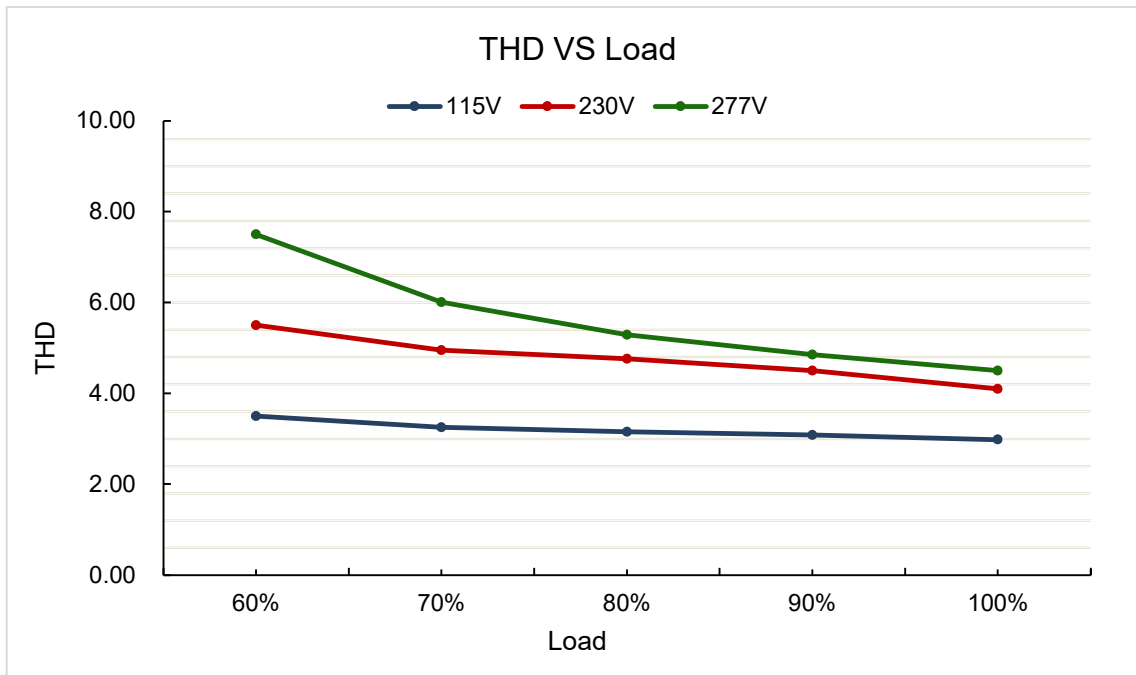

PROTECTIONS

Parameter	Notes
Over Temperature Protection	Decreases output current, returning to normal after over temperature is removed, exclude auxiliary power supply.
Short Circuit Protection	Hiccup mode and auto recovery. No damage will occur when any output is short circuited. The output shall return to normal when the fault condition is removed.
Over Voltage Protection	Run into protection model when output voltage exceeds limit, and return to normal when the fault.

DALI-2 DIMMING CURVE

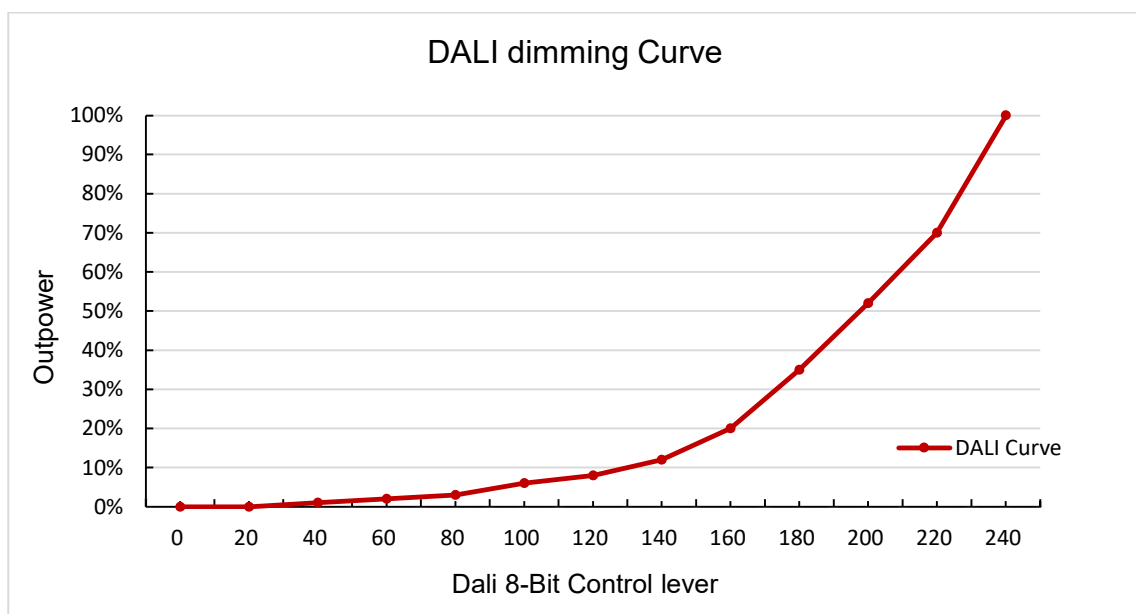

MECHANICAL OUTLINE

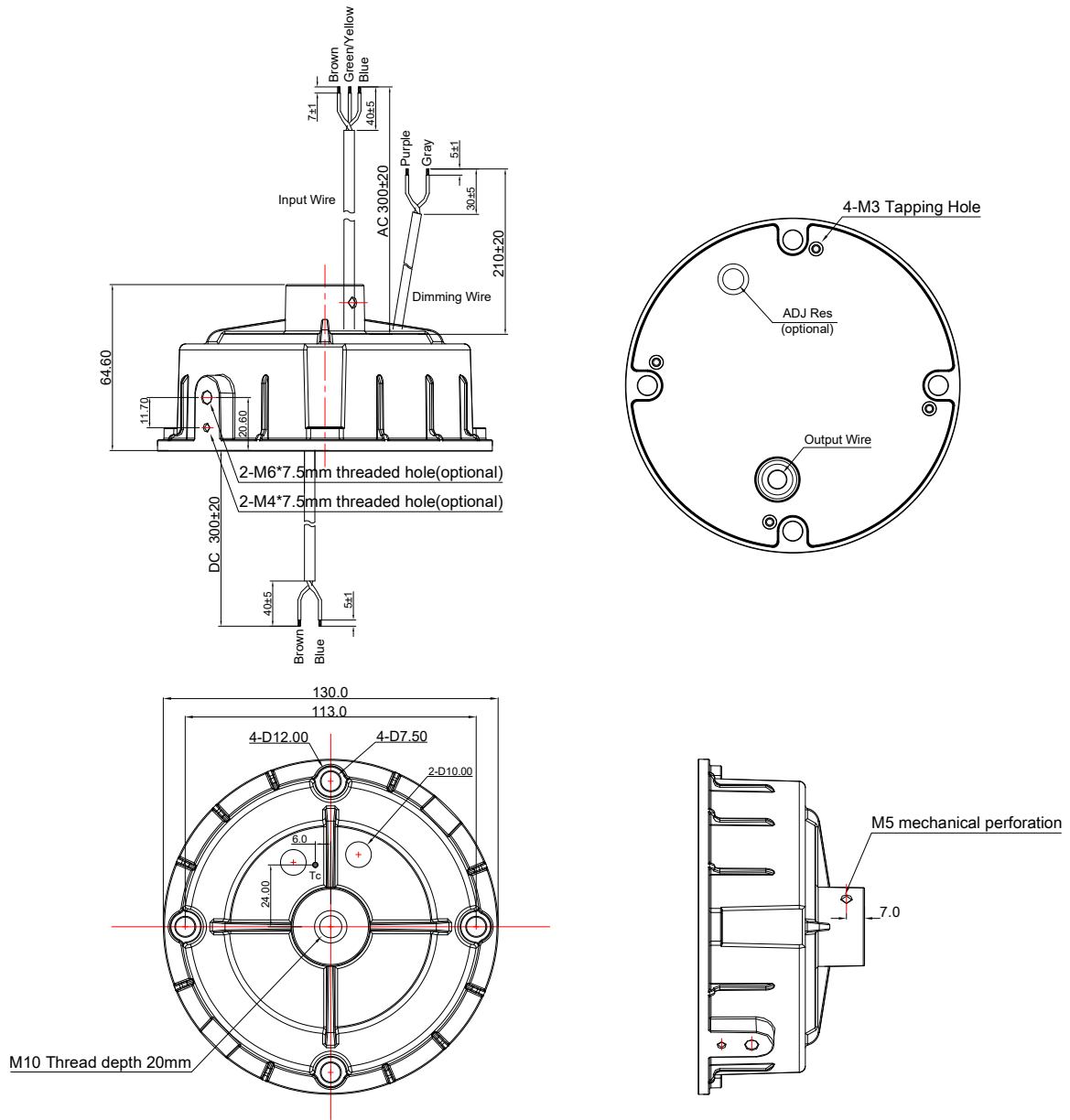

Note: Case color: RAL 9017 glossy black.

Wire	Specification	Note
Input	CCC+VDE 3x1.0mm ² L=300±20mm	CE
Output	CCC+VDE 2x1.0mm ² L=300±20mm	CE
Dimming	22AWG/2C L=210±20mm	

LABEL

Input	MOSO[®]	G6-200D260H Constant current type	DALI 2	Output				
L Brown	U _{out} (No Load) : 295V [~]		CE	Brown "+"				
G Y/G	<table border="1"> <tr> <td>Input</td> <td>100-277V ~ 50/60Hz, 3.0 A Max.</td> </tr> <tr> <td>Output</td> <td>Output voltage: 180-260V[~]; Irated: 0.093-0.930 A, Prated: 200W Max.</td> </tr> </table>		Input	100-277V ~ 50/60Hz, 3.0 A Max.	Output	Output voltage: 180-260V [~] ; Irated: 0.093-0.930 A, Prated: 200W Max.	t _c : 90°C t _a : 60°C	Blue "-"
Input	100-277V ~ 50/60Hz, 3.0 A Max.							
Output	Output voltage: 180-260V [~] ; Irated: 0.093-0.930 A, Prated: 200W Max.							
N Blue	  	IP65 RoHS	Control signal (DALI signal)	Purple DA Gray DA				
MADE IN CHINA For LED module only		SHENZHEN MOSO ELECTRONICS TECHNOLOGY CO., LTD No.1061, Songbai Road, Xili Town, Nanshan District, Shenzhen, CHINA	Patented Product Copyright reserved					
			 S20000A02F01					

Specification for Approval

Product Name: 200W Non-isolated DALI-2 LED driver

Product Model: G6-200D260H

Rev. A.0

CUSTOMER AUTHORIZED SIGNATURE		
Tested By	Checked By	Approved By
(Company seal)Return one copy to MOSO with approved signature and company seal.		

Prepared By	Checked By	Approved By